



MESSINA

Posuvný systém pro pergoly



DVOJKŘÍDLÝ SYSTÉM - JEDNOSTRANNÝ

POVRCHOVÁ
ÚPRAVA:

- RAL 9016
- RAL 1013
- RAL 9007
- RAL 8019
- RAL 7016
- RAL 8014
- RAL 9005

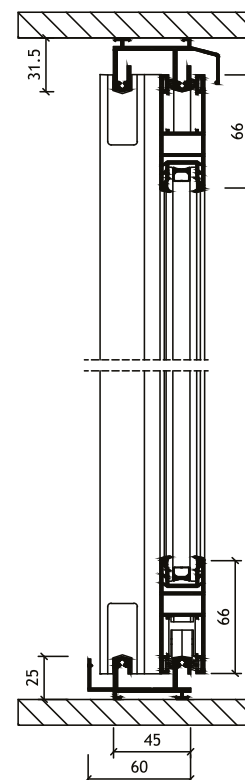
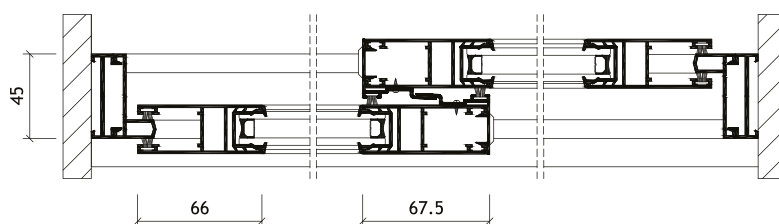
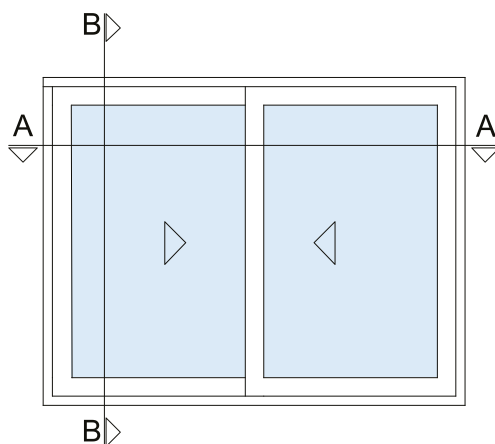

SKLO:

Varianta 1:

8,4 mm (VSG 4.4.1)

Varianta 2:

16 mm (ISO 4-8-4)

Cenovou nabídku zhotoví firma Bartosini® s.r.o., na základě požadavků klienta.





max. šířka systému (mm): **3200**
max. výška systému (mm): **2600**

max. šířka křídla VSG 44.1 (mm): **1600**
max. šířka křídla ISO 4-8-4 (mm): **1200**

max hmotnost/křídlo (kg): **100**

DVOJKŘÍDLÝ SYSTÉM - OBOUSTRANNÝ

POVRCHOVÁ
ÚPRAVA:

- RAL 9016 
- RAL 1013 
- RAL 9007 
- RAL 8019 
- RAL 7016 
- RAL 8014 
- RAL 9005 

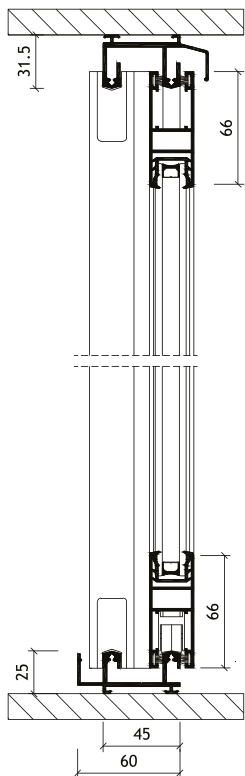
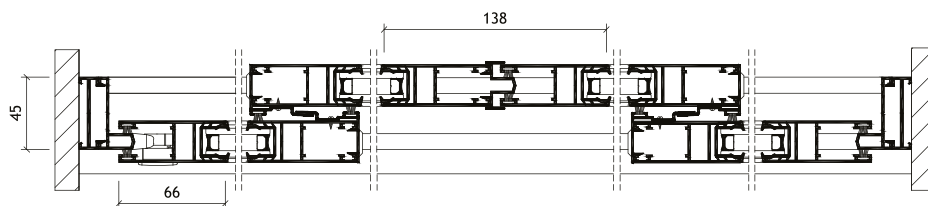
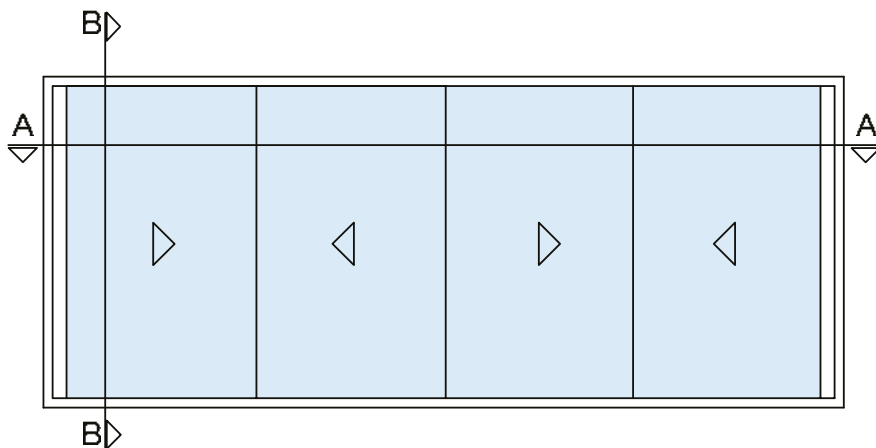

SKLO:

Varianta 1:

8,4 mm (VSG 4.4.1)

Varianta 2:

16 mm (ISO 4-8-4)

Cenovou nabídku zhotoví firma Bartosini® s.r.o., na základě požadavků klienta.

max. šířka křídla VSG 44.1 (mm): **1600**

max. šířka systému (mm): **6400**

max. šířka křídla ISO 4-8-4 (mm): **1200**

max. výška systému (mm): **2600**

max hmotnost/křídlo (kg): **100**

TROJKŘÍDLÝ SYSTÉM - JEDNOSTRANNÝ

POVRCHOVÁ
ÚPRAVA:

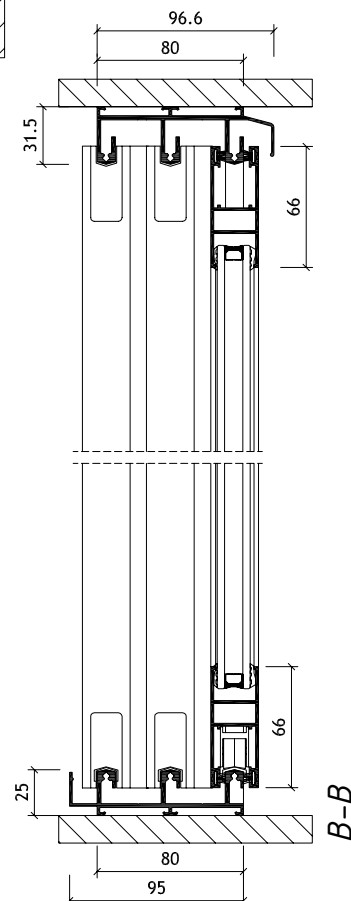
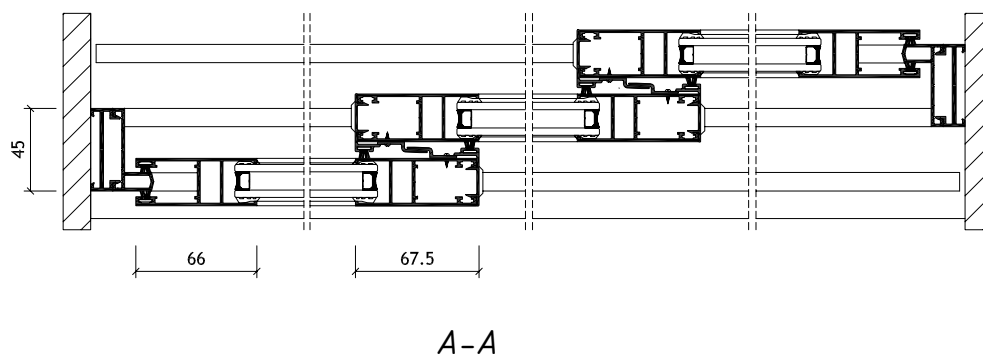
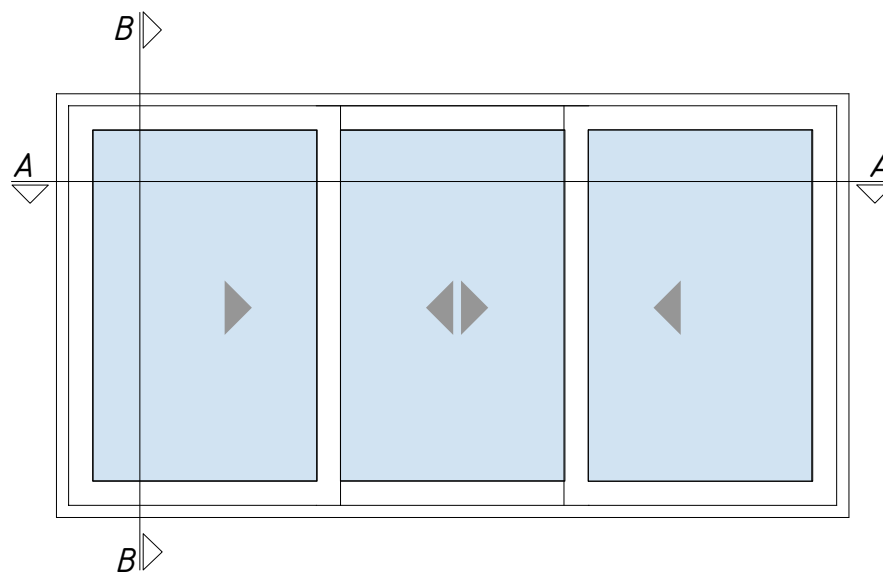
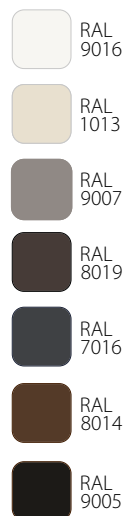

SKLO:

Varianta 1:

8,4 mm (VSG 4.4.1)

Varianta 2:

16 mm (ISO 4-8-4)

Cenovou nabídku zhotoví firma Bartosini® s.r.o., na základě požadavků klienta.

max. šířka systému (mm): **4670**

max. šířka křídla VSG 44.1 (mm): **1600**







max. výška systému (mm): **2600**

max. šířka křídla ISO 4-8-4 (mm): **1200**

max hmotnost/křídlo (kg): **100**

TROJKŘÍDLÝ SYSTÉM - OBOUSTRANNÝ

POVRCHOVÁ
ÚPRAVA:

- RAL 9016 
- RAL 1013 
- RAL 9007 
- RAL 8019 
- RAL 7016 
- RAL 8014 
- RAL 9005 

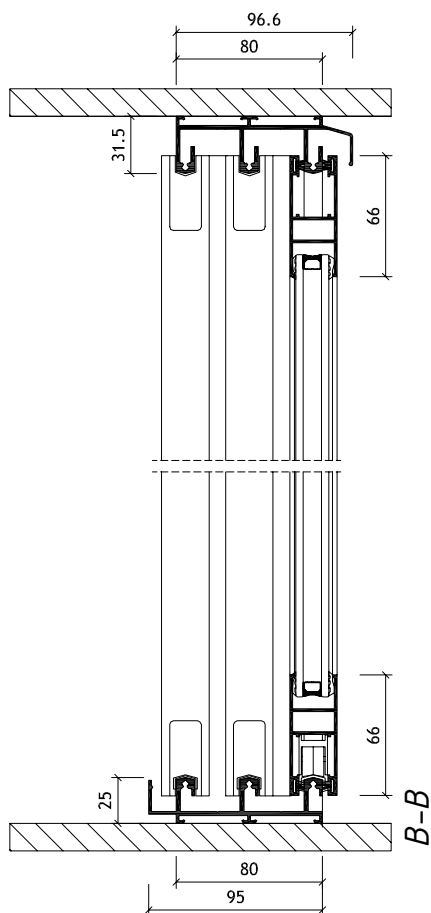
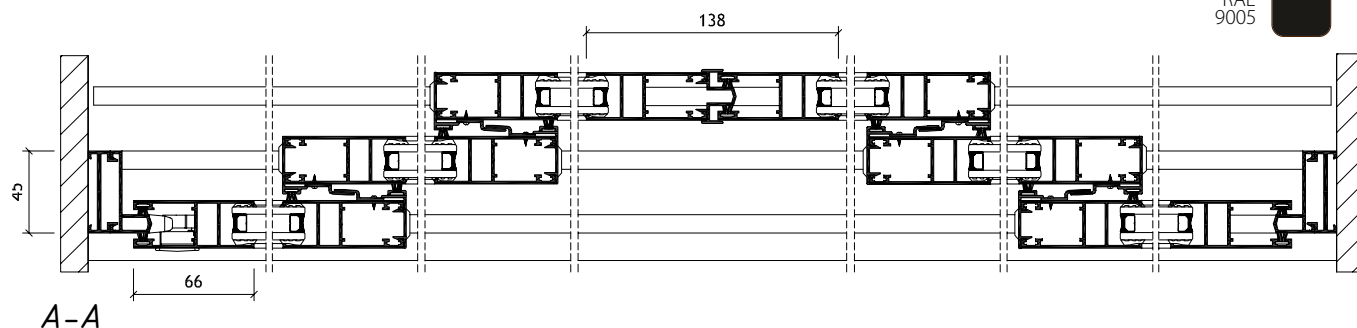
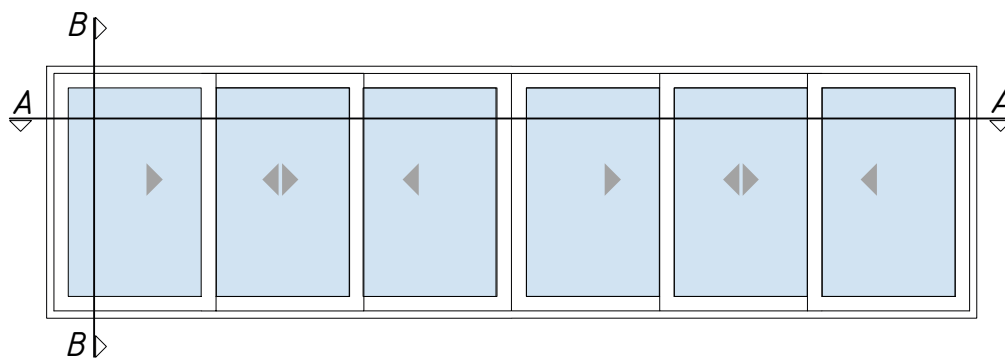

SKLO:

Varianta 1:

8,4 mm (VSG 4.4.1)

Varianta 2:

16 mm (ISO 4-8-4)

Cenovou nabídku zhotoví firma Bartosini® s.r.o., na základě požadavků klienta.

max. šířka křídla VSG 44.1(mm): **1600**

max. šířka systému (mm): **9340**







max. šířka křídla ISO 4-8-4 (mm): **1200**

max. výška systému (mm): **2600**

max hmotnost/křídlo (kg): **100**

ČTYŘKŘÍDLÝ SYSTÉM - JEDNOSTRANNÝ

POVRCHOVÁ
ÚPRAVA:

-  RAL 9016
-  RAL 1013
-  RAL 9007
-  RAL 8019
-  RAL 7016
-  RAL 8014
-  RAL 9005

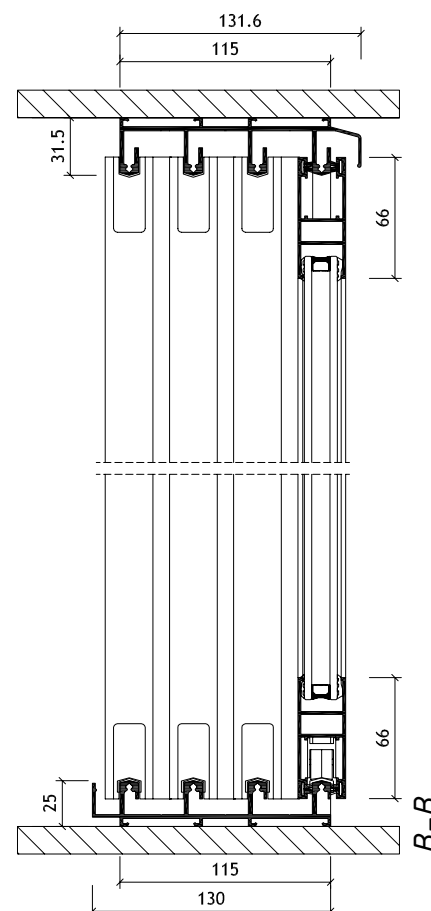
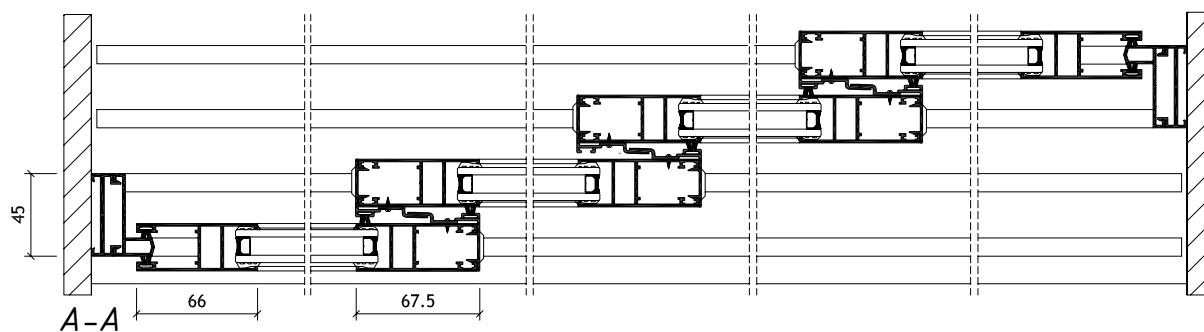
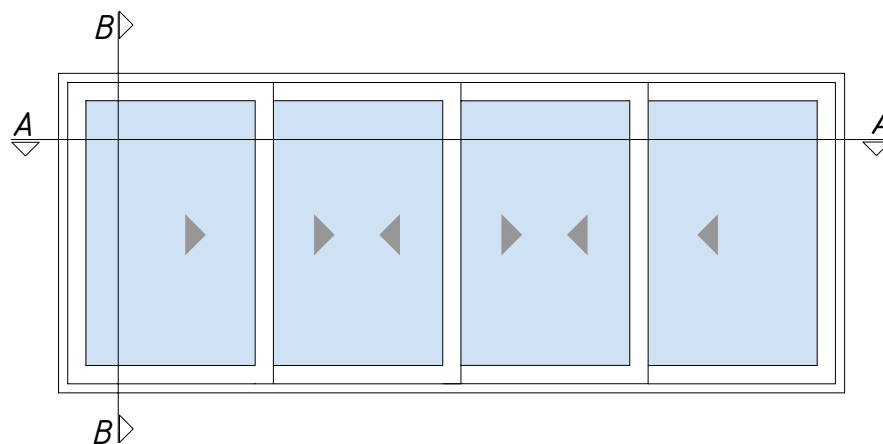

SKLO:

Varianta 1:

8,4 mm (VSG 4.4.1)

Varianta 2:

16 mm (ISO 4-8-4)

Cenovou nabídku zhotoví firma Bartosini® s.r.o., na základě požadavků klienta.

max. šířka systému (mm): 6000

max. šířka křídla VSG 44.1 (mm): 1600

max. výška systému (mm): 2600

max. šířka křídla ISO 4-8-4 (mm): 1200

max hmotnost/křídlo (kg): 100

ČTYŘKŘÍDLÝ SYSTÉM - OBOUSTRANNÝ

POVRCHOVÁ
ÚPRAVA:

RAL 9016

RAL 1013

RAL 9007

RAL 8019

RAL 7016

RAL 8014

RAL 9005

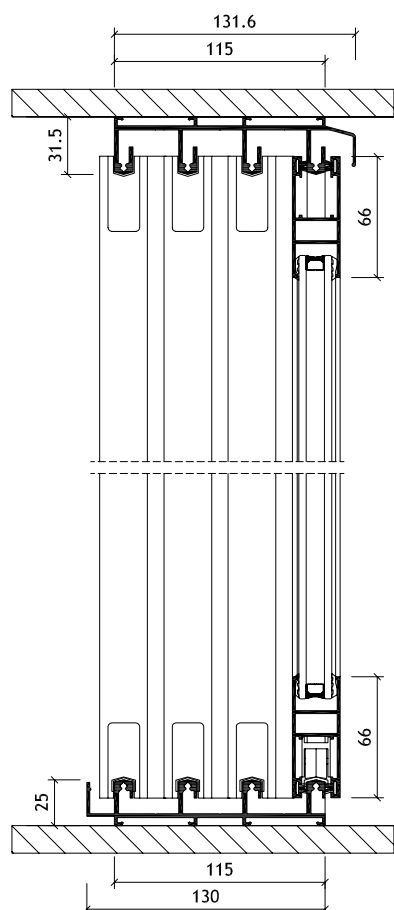
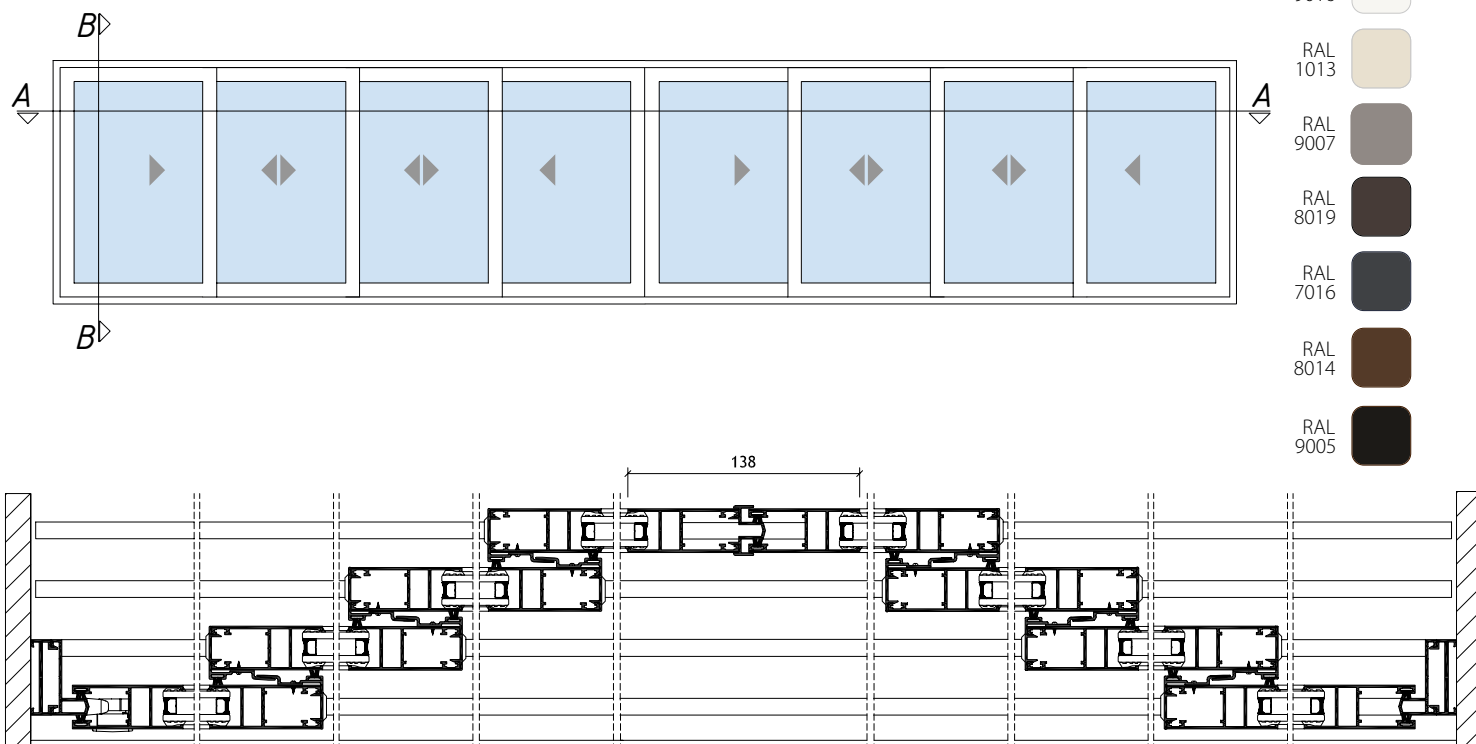

SKLO:

Varianta 1:

8,4 mm (VSG 4.4.1)

Varianta 2:

16 mm (ISO 4-8-4)

Cenovou nabídku zhotoví firma Bartosini® s.r.o., na základě požadavků klienta.

max. šířka křídla VSG 44.1 (mm): **1600**

max. šířka systému (mm): **12000**

max. šířka křídla ISO 4-8-4 (mm): **1200**

max. výška systému (mm): **2600**

max hmotnost/křídlo (kg): **100**

PĚTIKŘÍDLÝ SYSTÉM - JEDNOSTRANNÝ

POVRCHOVÁ
ÚPRAVA:

- RAL 9016
- RAL 1013
- RAL 9007
- RAL 8019
- RAL 7016
- RAL 8014
- RAL 9005

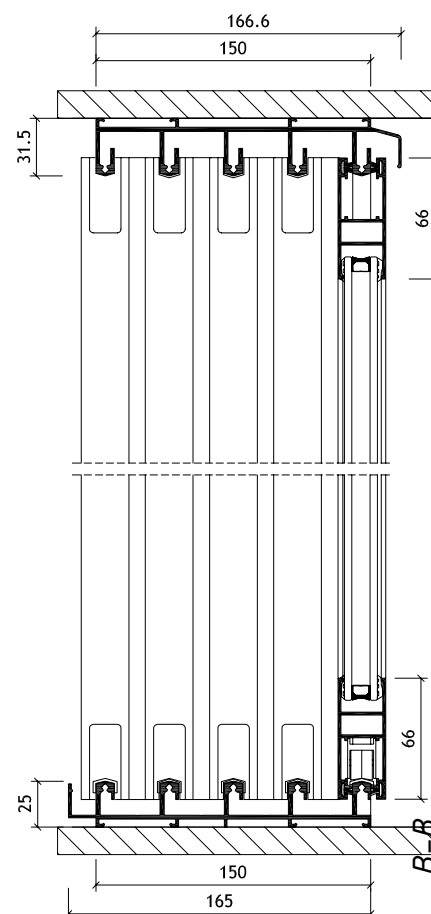
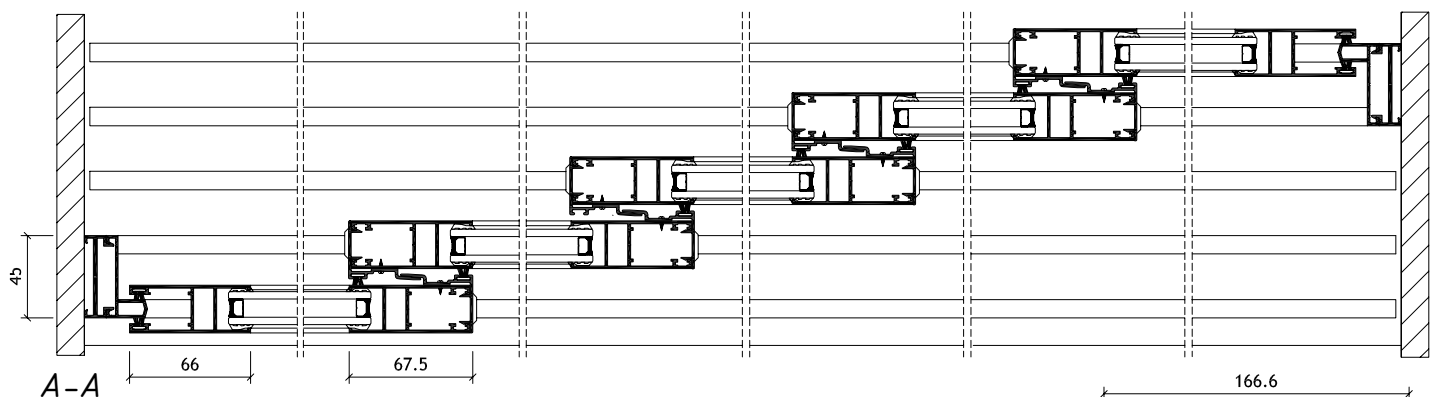
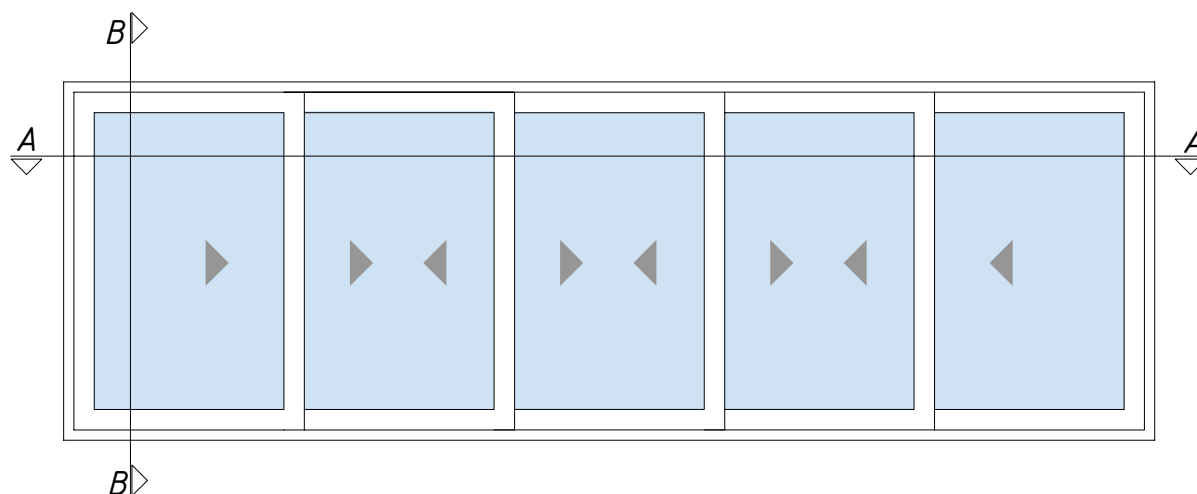

SKLO:

Varianta 1:

8,4 mm (VSG 4.4.1)

Varianta 2:

16 mm (ISO 4-8-4)

Cenovou nabídku zhotoví firma Bartosini® s.r.o., na základě požadavků klienta.

max. šířka systému (mm): 7740

max. šířka křídla VSG 44.1 (mm): 1600







max. výška systému (mm): 2600

max. šířka křídla ISO 4-8-4 (mm): 1200

max hmotnost/křídlo (kg): 100

PĚTIKŘÍDLÝ SYSTÉM - OBOUSTRANNÝ

POVRCHOVÁ
ÚPRAVA:

- RAL 9016 
- RAL 1013 
- RAL 9007 
- RAL 8019 
- RAL 7016 
- RAL 8014 
- RAL 9005 

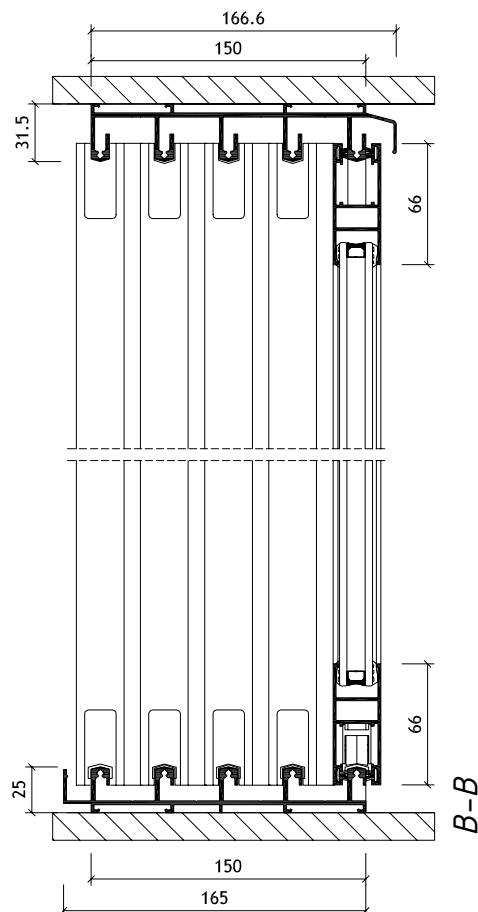
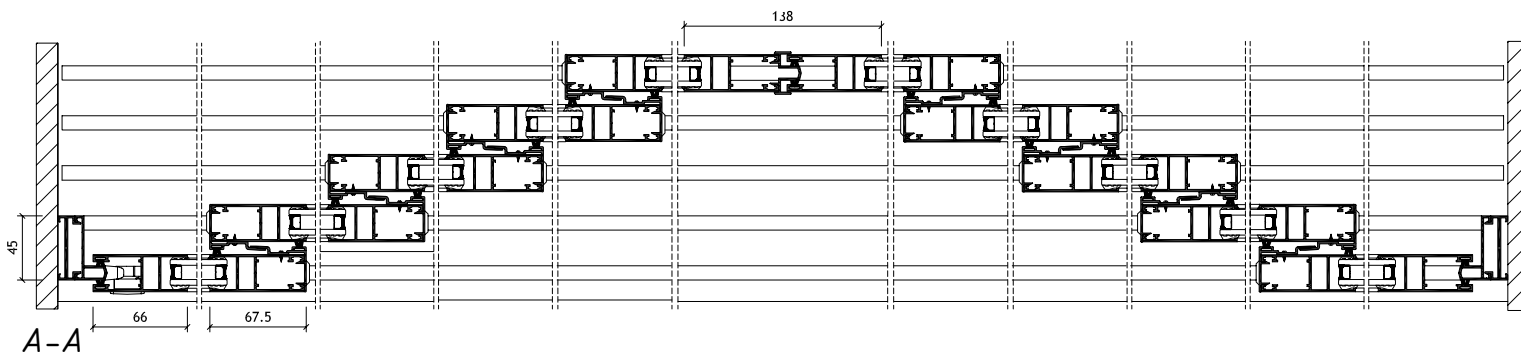
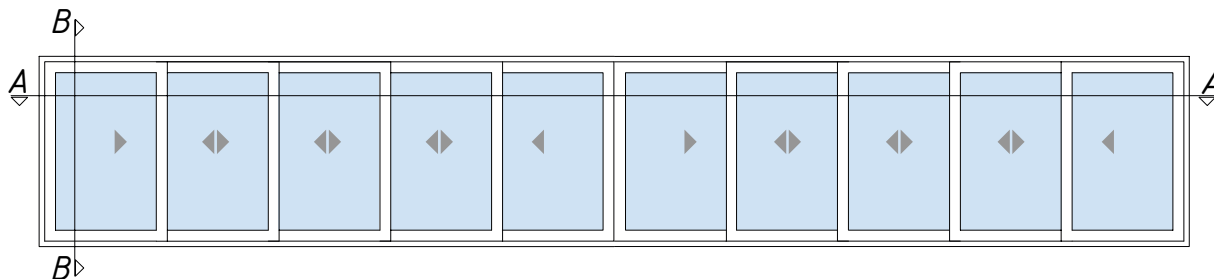

max hmotnost/křídlo (kg): 100

SKLO:

Varianta 1:

8,4 mm (VSG 4.4.1)

Varianta 2:

16 mm (ISO 4-8-4)

Cenovou nabídku zhotoví firma Bartosini® s.r.o., na základě požadavků klienta.

max. šířka křídla VSG 44.1 (mm): **1600**

max. šířka systému (mm): **15480**

max. šířka křídla ISO 4-8-4 (mm): **1200**

max. výška systému (mm): **2600**

STANDARDNÍ MADLO S ARETACÍ

Zapuštěné madlo s aretací pro krajní panely, bez uzamykání (jednostranné)

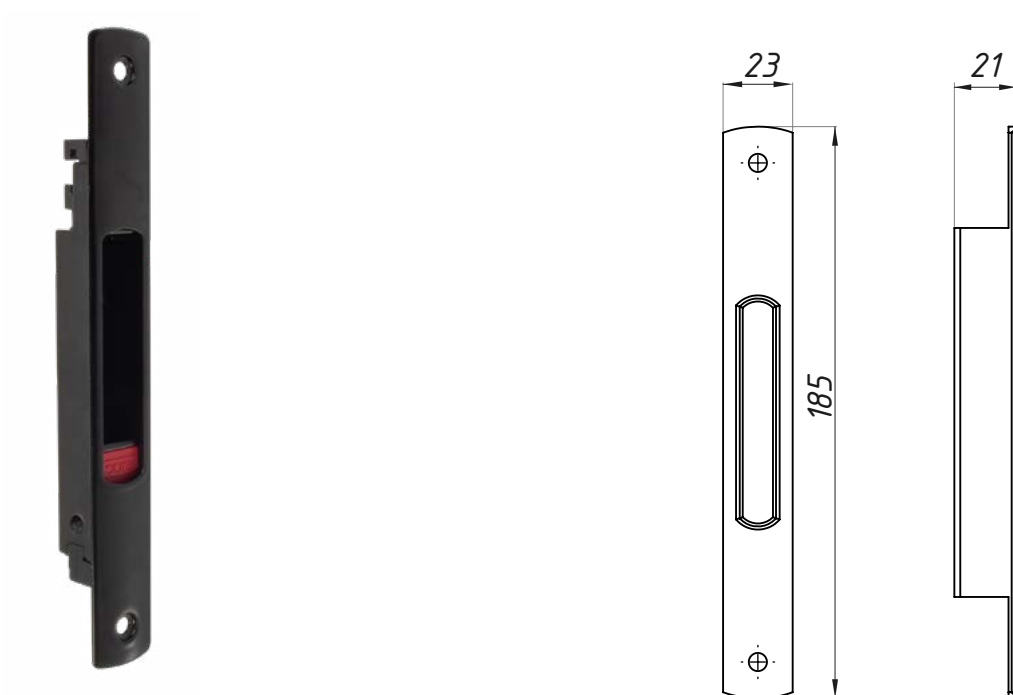

Cenovou nabídku zhotoví firma Bartosini® s.r.o., na základě požadavků klienta.

MADLO

Jednostranné madlo pro teleskopické dveře, hranaté

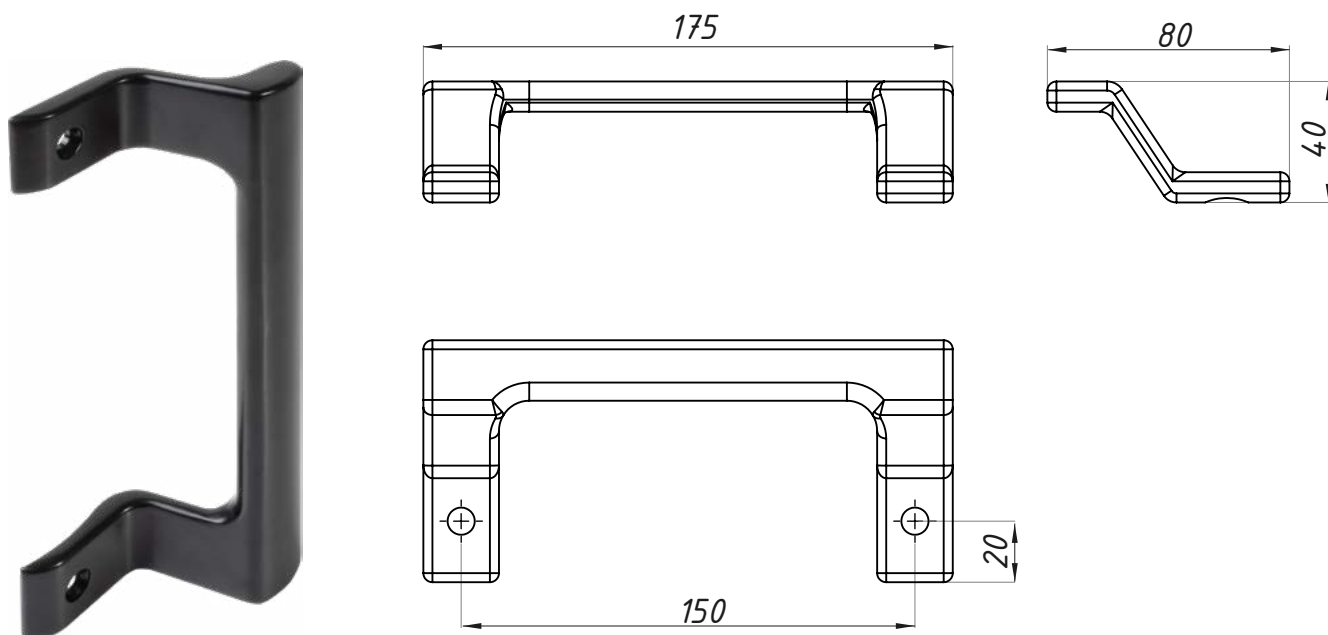

Cenovou nabídku zhotoví firma Bartosini® s.r.o., na základě požadavků klienta.

KLIKA

Oboustranná klika s cylindrickou vložkou

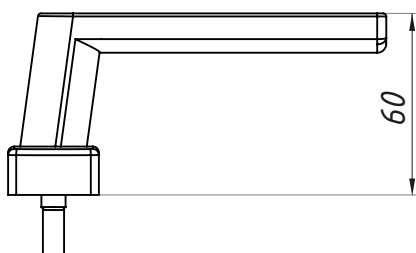
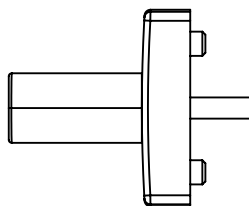
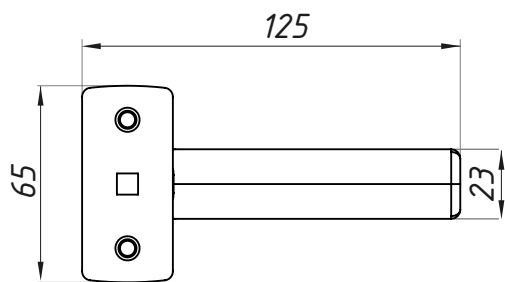

Cenovou nabídku zhotoví firma Bartosini® s.r.o., na základě požadavků klienta.

