



# OLIVERI

Bezrámový teleskopický posuvný systém



## DVOUKŘÍDLÝ SYSTÉM - JEDNOSTRANNÝ

POVRCHOVÁ  
ÚPRAVA:

- RAL 9016
- RAL 1013
- RAL 9007
- RAL 8019
- RAL 7016
- RAL 8014
- RAL 9005

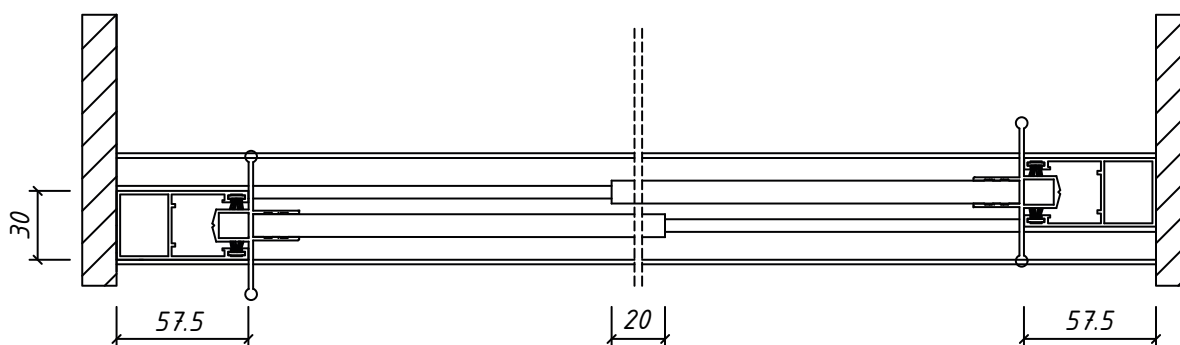
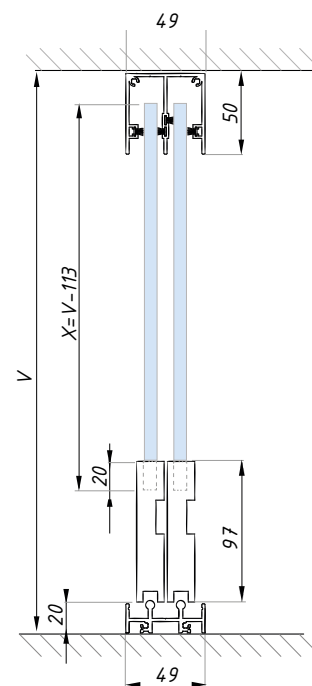
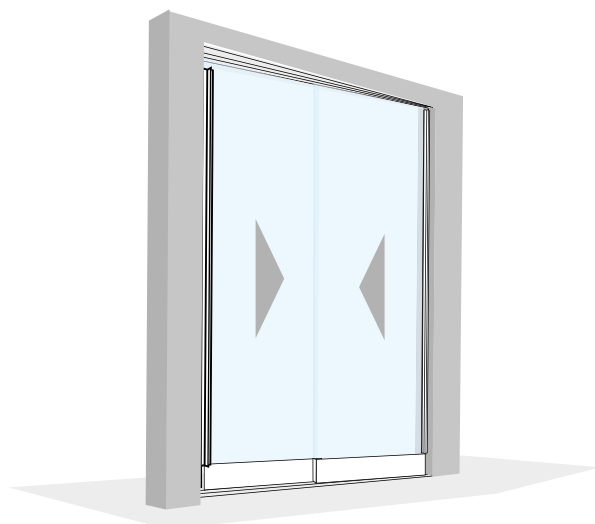

SKLO:

ESG 10 mm

max. šířka křídla: 1000







max. výška křídla: 2700

max hmotnost/křídlo (kg): 100

Cenovou nabídku zhotoví firma Bartosini® s.r.o., na základě požadavků klienta.

# DVOUKŘÍDLÝ SYSTÉM - OBOUSTRANNÝ

POVRCHOVÁ  
ÚPRAVA:

- RAL 9016 
- RAL 1013 
- RAL 9007 
- RAL 8019 
- RAL 7016 
- RAL 8014 
- RAL 9005 

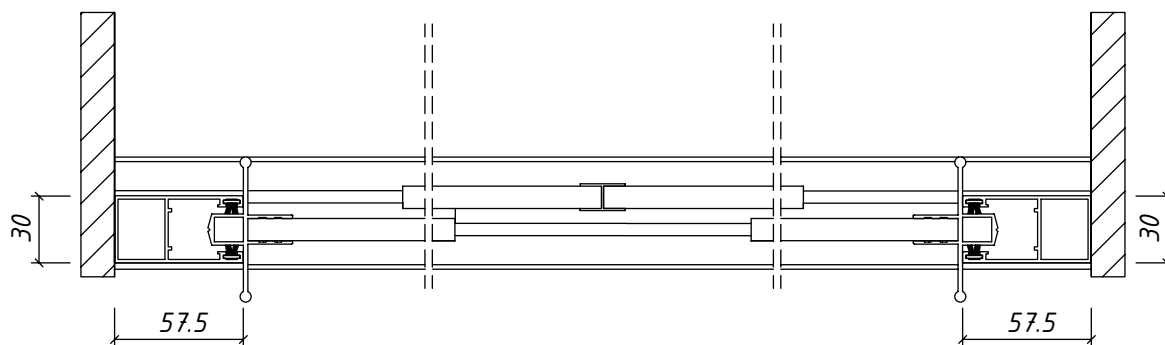
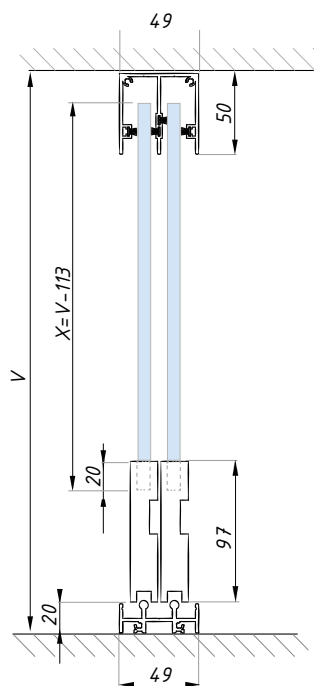
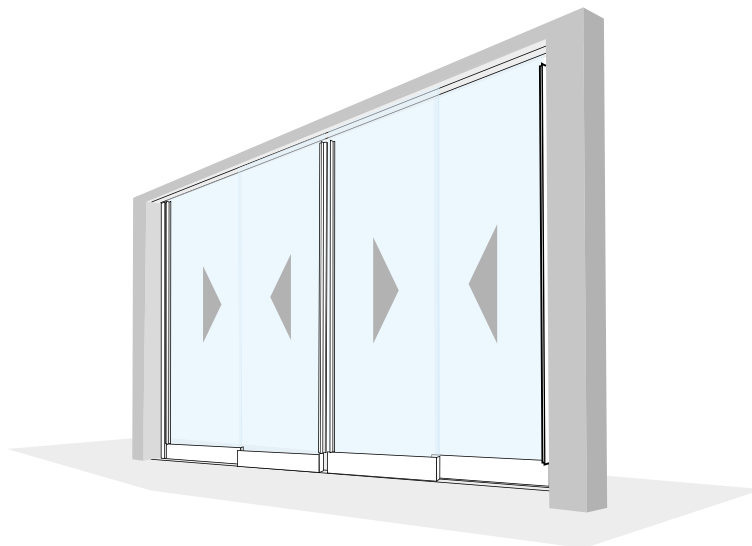

SKLO:  
ESG 10 mm

max. šířka křídla: 1000







max hmotnost/křídlo (kg): 100

max. výška křídla: 2700

Cenovou nabídku zhotoví firma Bartosini® s.r.o., na základě požadavků klienta.

## TROJKŘÍDLÝ SYSTÉM - JEDNOSTRANNÝ

POVRCHOVÁ  
ÚPRAVA:

-  RAL 9016
-  RAL 1013
-  RAL 9007
-  RAL 8019
-  RAL 7016
-  RAL 8014
-  RAL 9005

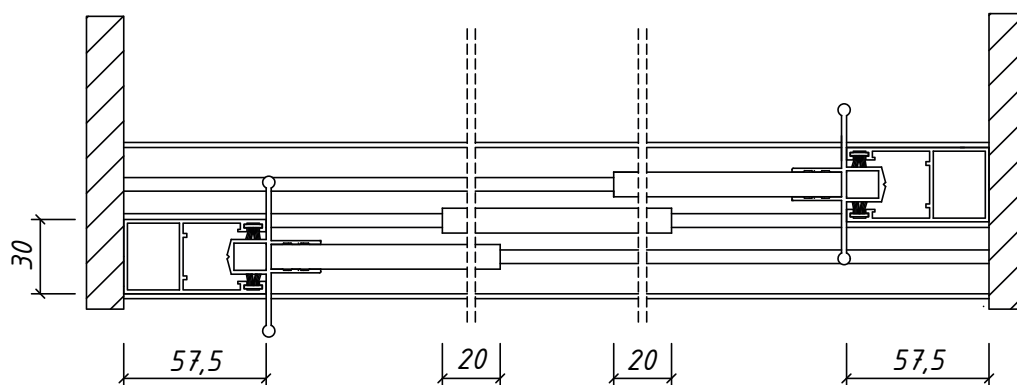
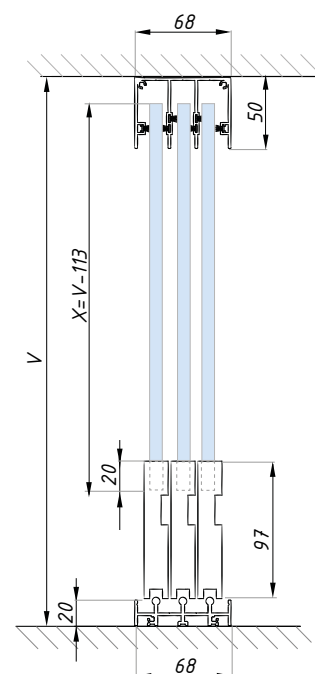
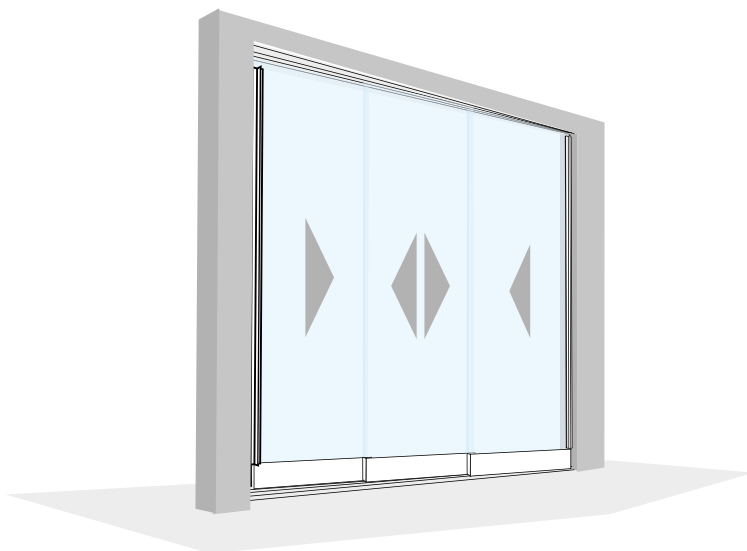

SKLO:

ESG 10 mm

max. šířka křídla: 1000

max. výška křídla: 2700

max hmotnost/křídlo (kg): 100

Cenovou nabídku zhotoví firma Bartosini® s.r.o., na základě požadavků klienta.

# TROJKŘÍDLÝ SYSTÉM - OBOUSTRANNÝ

POVRCHOVÁ  
ÚPRAVA:

RAL 9016

RAL 1013

RAL 9007

RAL 8019

RAL 7016

RAL 8014

RAL 9005

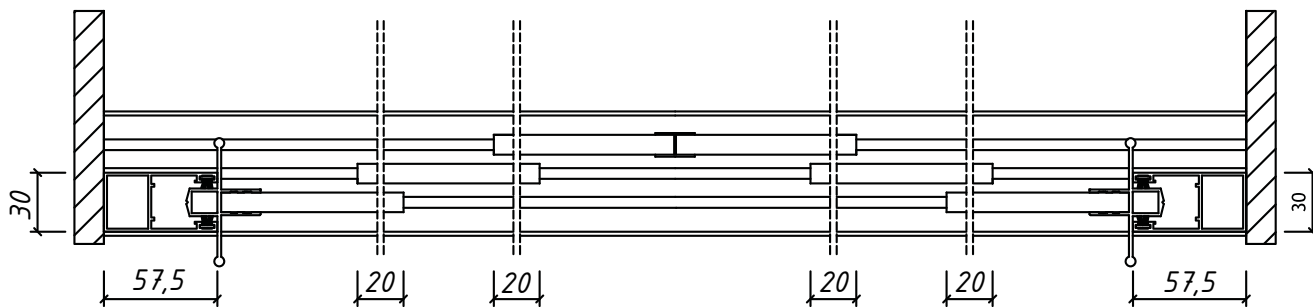
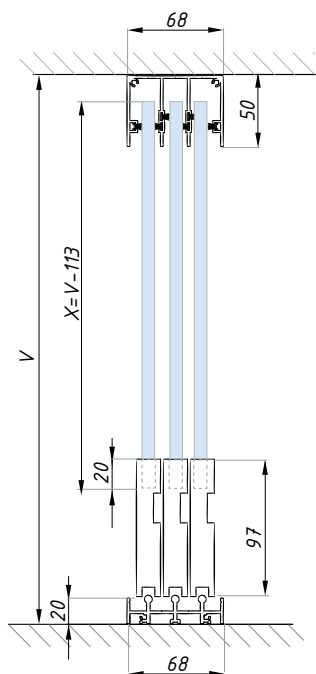
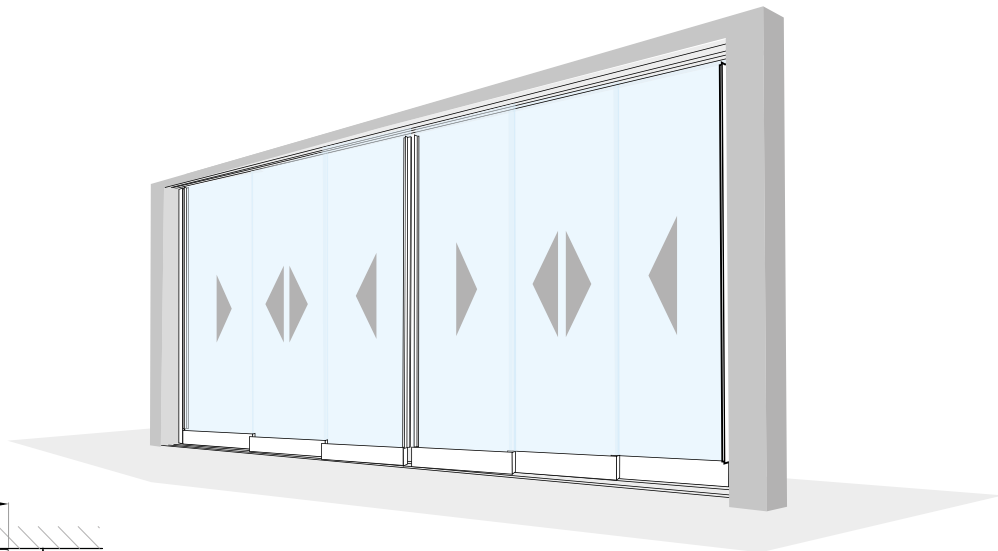

SKLO:

ESG 10 mm

max. šířka křídla: 1000







max hmotnost/křídlo (kg): 100

max. výška křídla: 2700

Cenovou nabídku zhotoví firma Bartosini® s.r.o., na základě požadavků klienta.

## ČTYŘKŘÍDLÝ SYSTÉM - JEDNOSTRANNÝ

POVRCHOVÁ  
ÚPRAVA:

-  RAL 9016
-  RAL 1013
-  RAL 9007
-  RAL 8019
-  RAL 7016
-  RAL 8014
-  RAL 9005

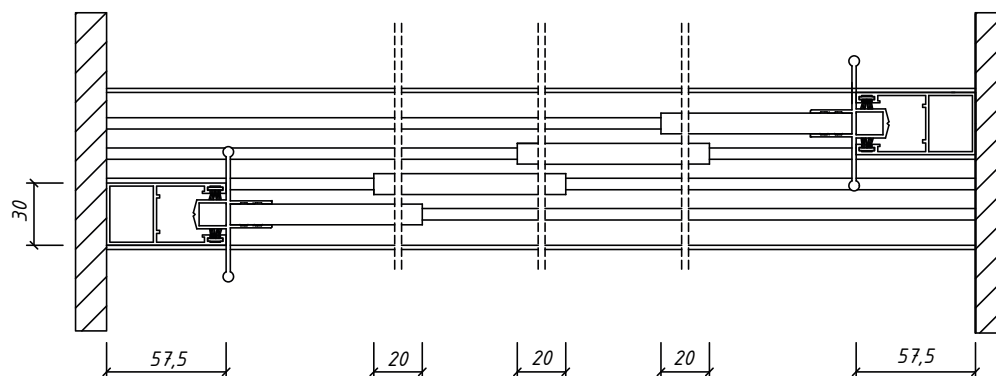
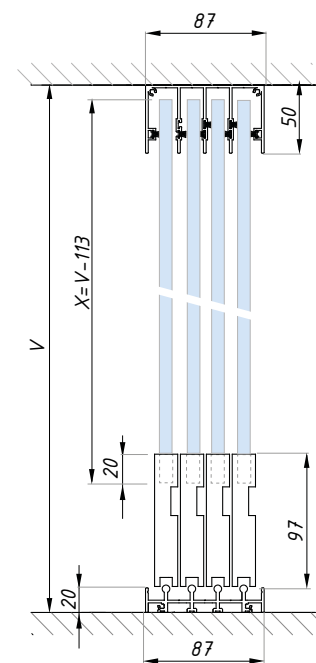
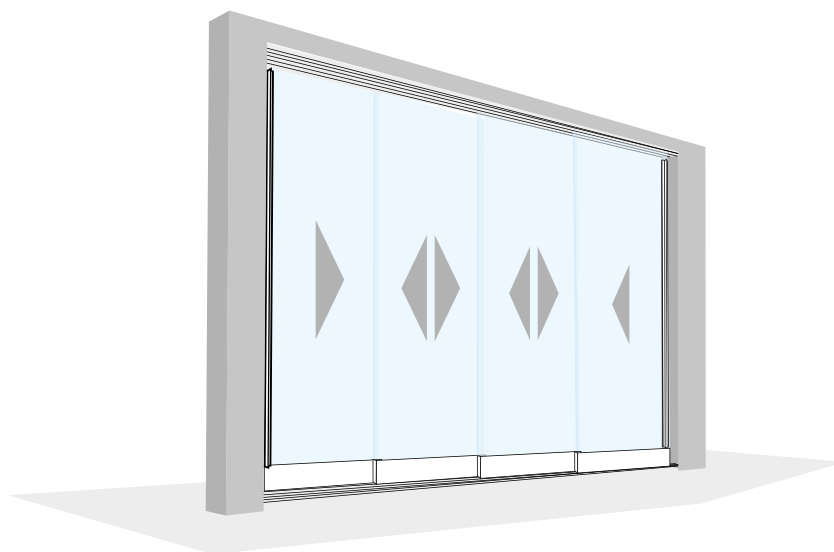

SKLO:

ESG 10 mm

max. šířka křídla: 1000

max. výška křídla: 2700

max hmotnost/křídlo (kg): 100

Cenovou nabídku zhotoví firma Bartosini® s.r.o., na základě požadavků klienta.

# ČTYŘKŘÍDLÝ SYSTÉM - OBOUSTRANNÝ

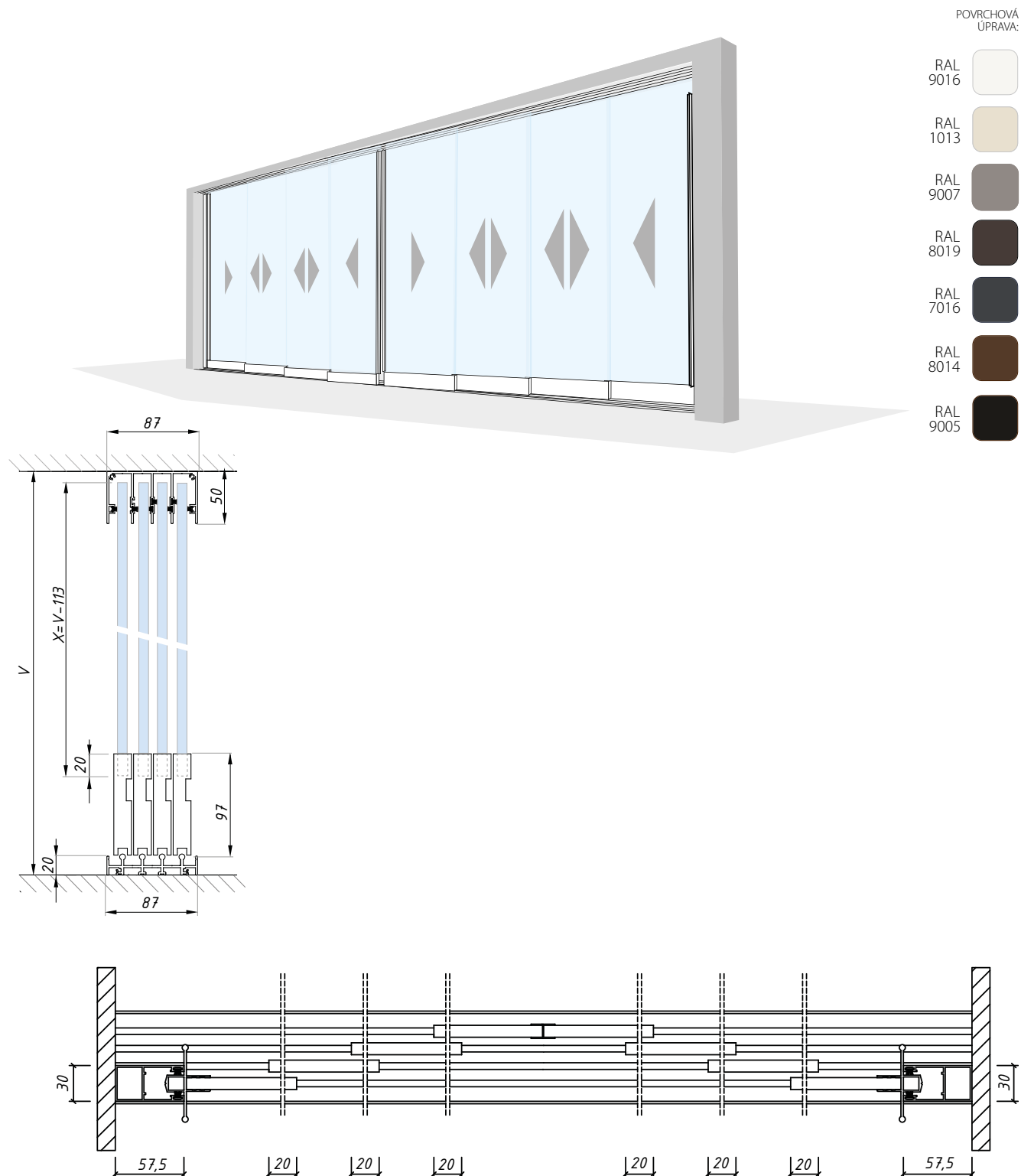

POVRCHOVÁ  
ÚPRAVA:

- RAL 9016
- RAL 1013
- RAL 9007
- RAL 8019
- RAL 7016
- RAL 8014
- RAL 9005

SKLO:

ESG 10 mm

max. šířka křídla: 1000







max hmotnost/křídlo (kg): 100

max. výška křídla: 2700

Cenovou nabídku zhotoví firma Bartosini® s.r.o., na základě požadavků klienta.

## PĚTIKŘÍDLÝ SYSTÉM - JEDNOSTRANNÝ

POVRCHOVÁ  
ÚPRAVA:

-  RAL 9016
-  RAL 1013
-  RAL 9007
-  RAL 8019
-  RAL 7016
-  RAL 8014
-  RAL 9005

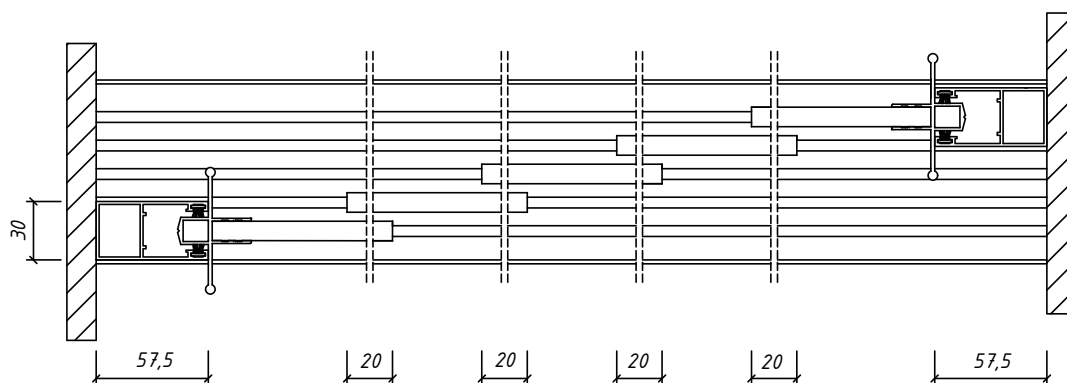
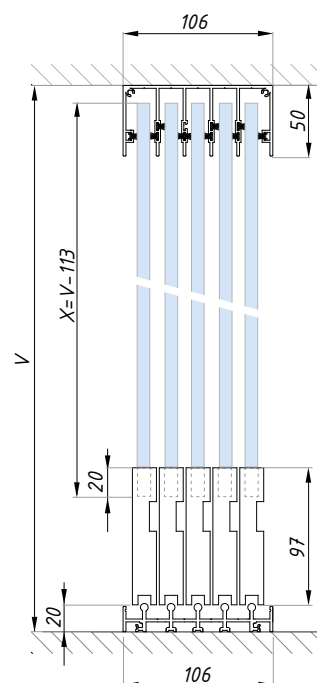
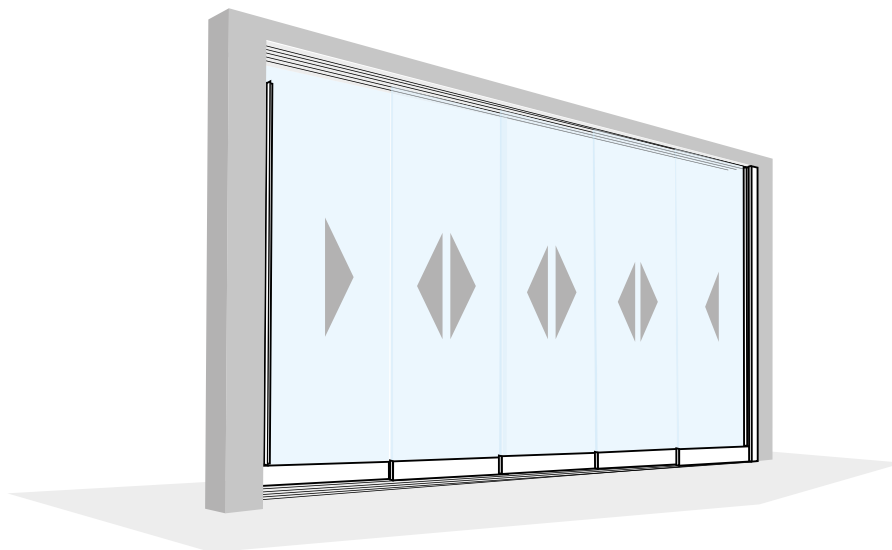

SKLO:

ESG 10 mm

max. šířka křídla: 1000

max. výška křídla: 2700

max hmotnost/křídlo (kg): 100

Cenovou nabídku zhotoví firma Bartosini® s.r.o., na základě požadavků klienta.



# PĚTIKŘÍDLÝ SYSTÉM - OBOUSTRANNÝ

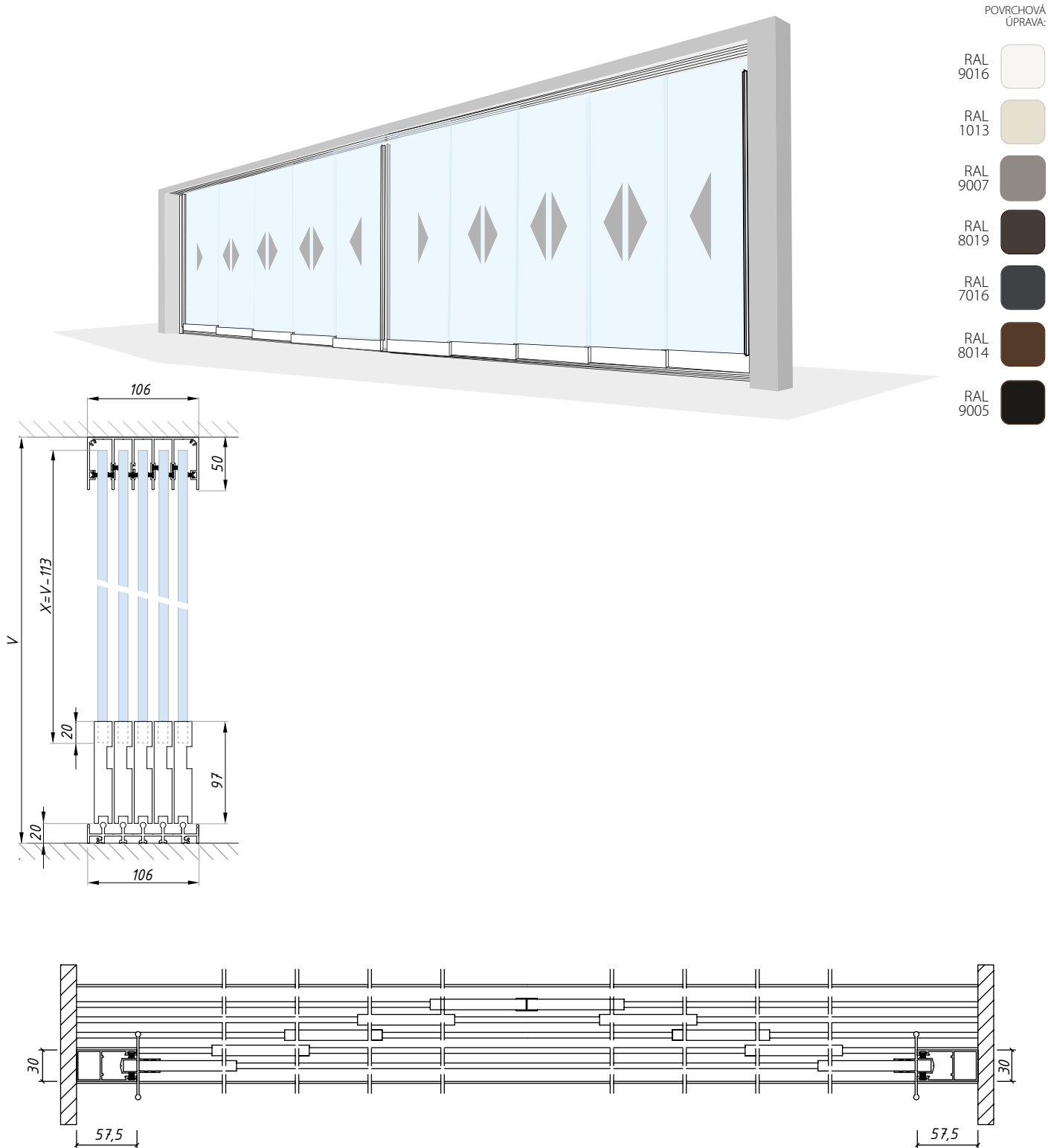

POVRCHOVÁ  
ÚPRAVA:

RAL 9016

RAL 1013

RAL 9007

RAL 8019

RAL 7016

RAL 8014

RAL 9005

SKLO:

ESG 10 mm

max. šířka křídla: 1000







max hmotnost/křídlo (kg): 100

max. výška křídla: 2700

Cenovou nabídku zhotoví firma Bartosini® s.r.o., na základě požadavků klienta.

## ŠESTIKŘÍDLÝ SYSTÉM - JEDNOSTRANNÝ

POVRCHOVÁ  
ÚPRAVA:

-  RAL 9016
-  RAL 1013
-  RAL 9007
-  RAL 8019
-  RAL 7016
-  RAL 8014
-  RAL 9005

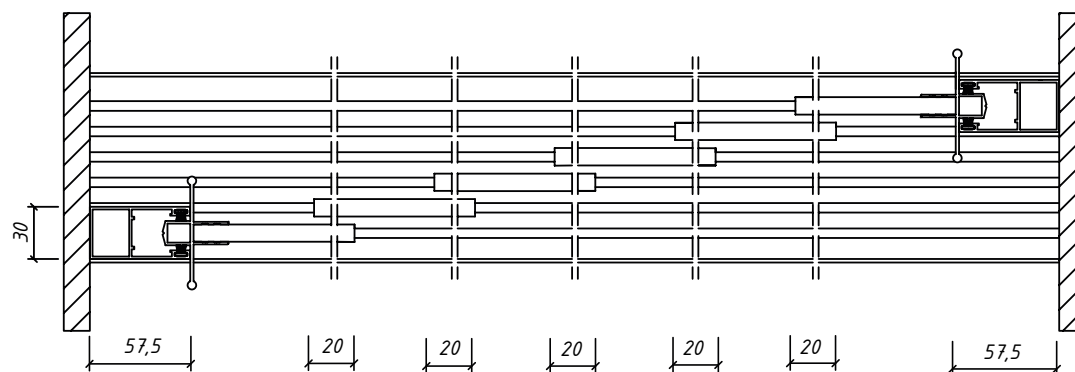
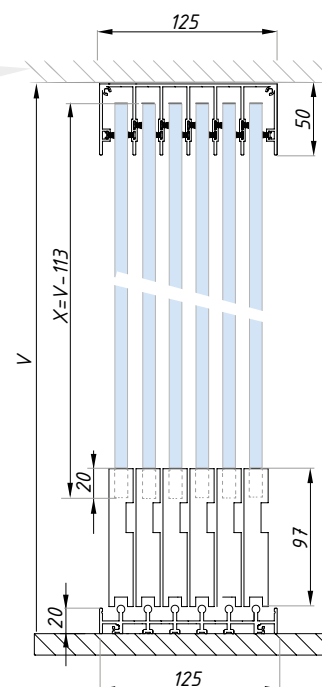
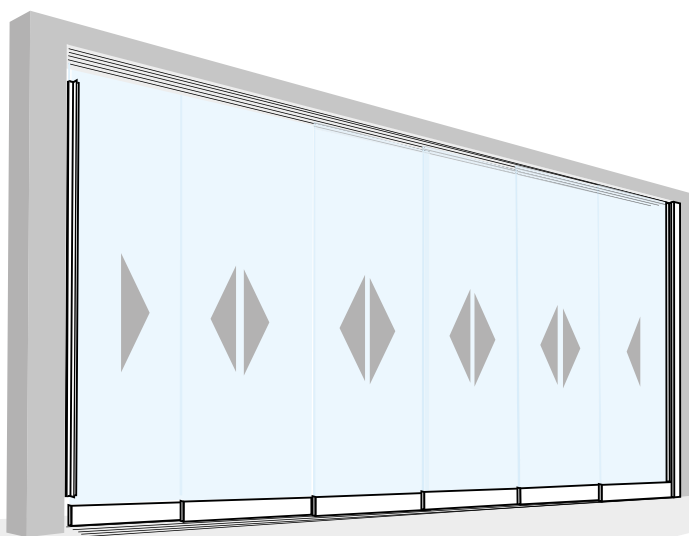

SKLO:

ESG 10 mm

max. šířka křídla: 1000

max. výška křídla: 2700

max. hmotnost/křídlo (kg): 100

Cenovou nabídku zhotoví firma Bartosini® s.r.o., na základě požadavků klienta.

## ŠESTIKŘÍDLÝ SYSTÉM - OBOUSTRANNÝ

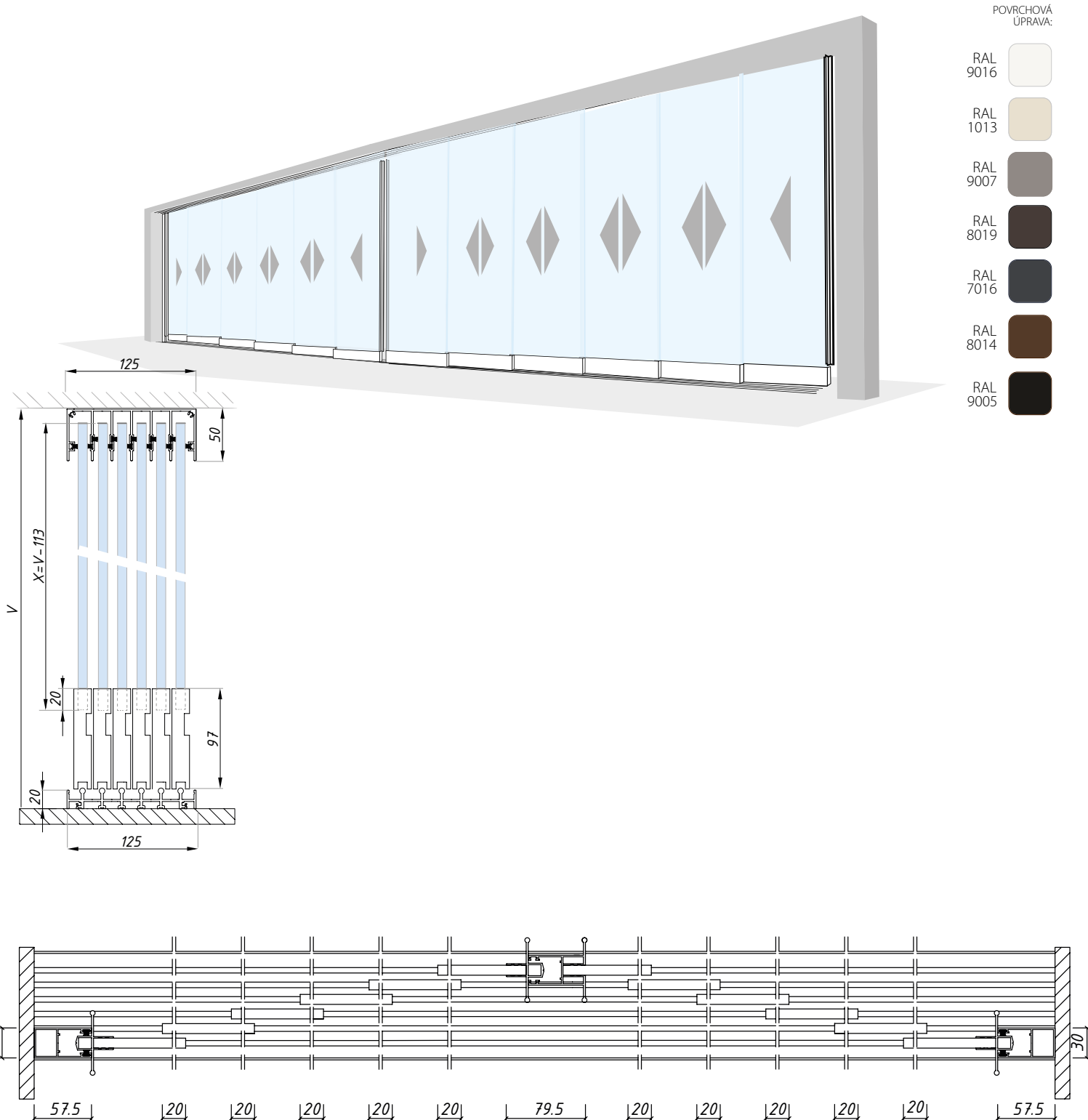

POVRCHOVÁ  
ÚPRAVA:

- RAL 9016 
- RAL 1013 
- RAL 9007 
- RAL 8019 
- RAL 7016 
- RAL 8014 
- RAL 9005 

SKLO:

ESG 10 mm

max. šířka křídla: 1000

max hmotnost/křídlo (kg): 100

max. výška křídla: 2700

Cenovou nabídku zhotoví firma Bartosini® s.r.o., na základě požadavků klienta.

## STANDARDNÍ MADLO S ARETACÍ

Zapuštěné madlo s aretací pro krajní panely, bez uzamykání (jednostranné)

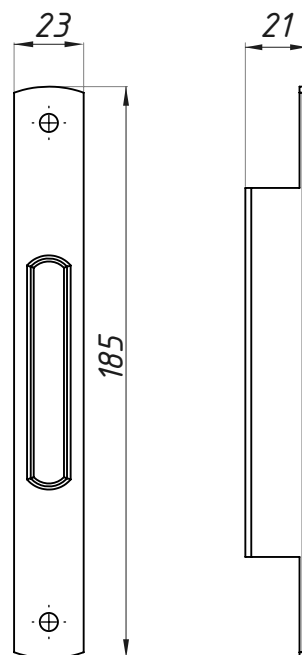

Cenovou nabídku zhotoví firma Bartosini® s.r.o., na základě požadavků klienta.

## KLIKA

Oboustranná klika s cylindrickou vložkou

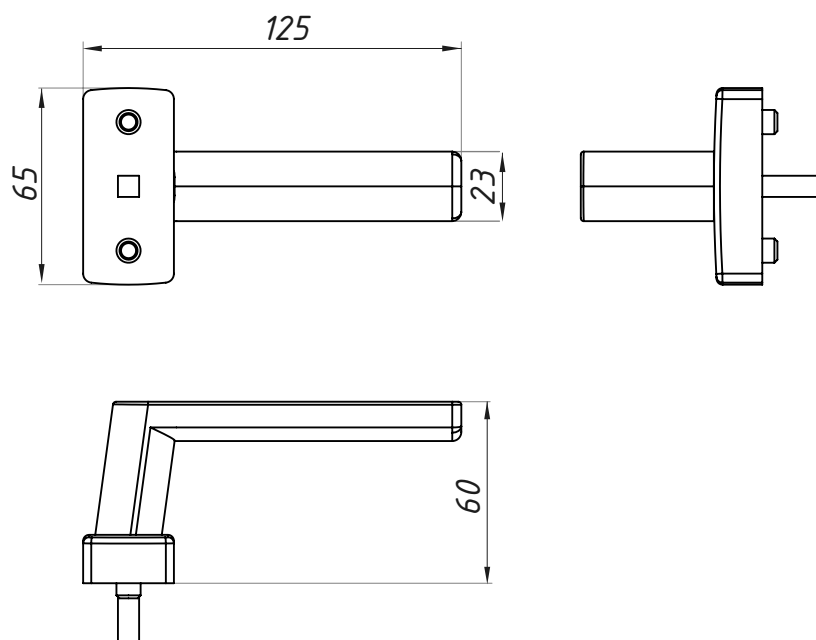

Cenovou nabídku zhotoví firma Bartosini® s.r.o., na základě požadavků klienta.

## KRYCÍ PROFIL

Boční krycí profil kolejniče, šikmý

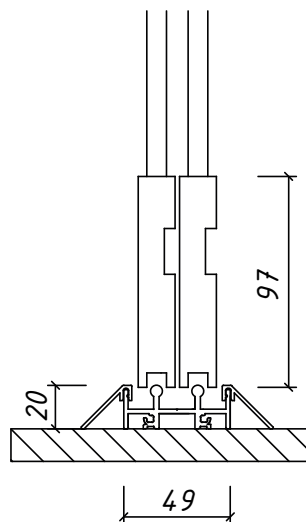
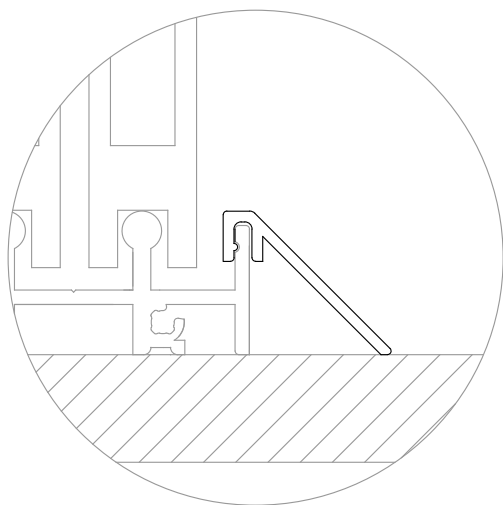

POVRCHOVÁ  
ÚPRAVA:

- RAL 9016 
- RAL 1013 
- RAL 9007 
- RAL 8019 
- RAL 7016 
- RAL 8014 
- RAL 9005 





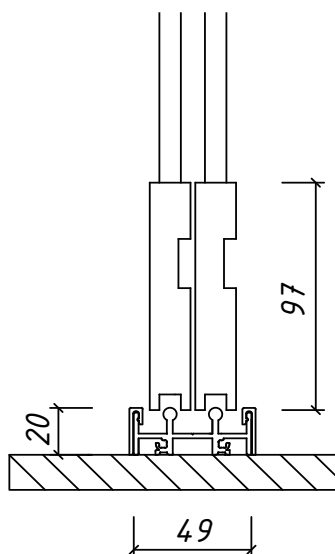
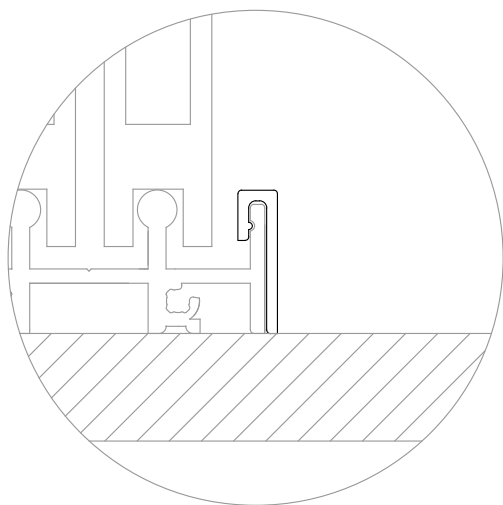

Cenovou nabídku zhotoví firma Bartosini® s.r.o., na základě požadavků klienta.

## KRYCÍ PROFIL

Boční krycí profil kolejniče, kolmý



POVRCHOVÁ  
ÚPRAVA:







- RAL 9016 
- RAL 1013 
- RAL 9007 
- RAL 8019 
- RAL 7016 
- RAL 8014 
- RAL 9005 

Cenovou nabídku zhotoví firma Bartosini® s.r.o., na základě požadavků klienta.

## SPOJ ROHOVÉHO SYSTÉMU

Set spojovacích profilů rohového systému 90°

POVRCHOVÁ  
ÚPRAVA:

-  RAL 9016
-  RAL 1013
-  RAL 9007
-  RAL 8019
-  RAL 7016
-  RAL 8014
-  RAL 9005

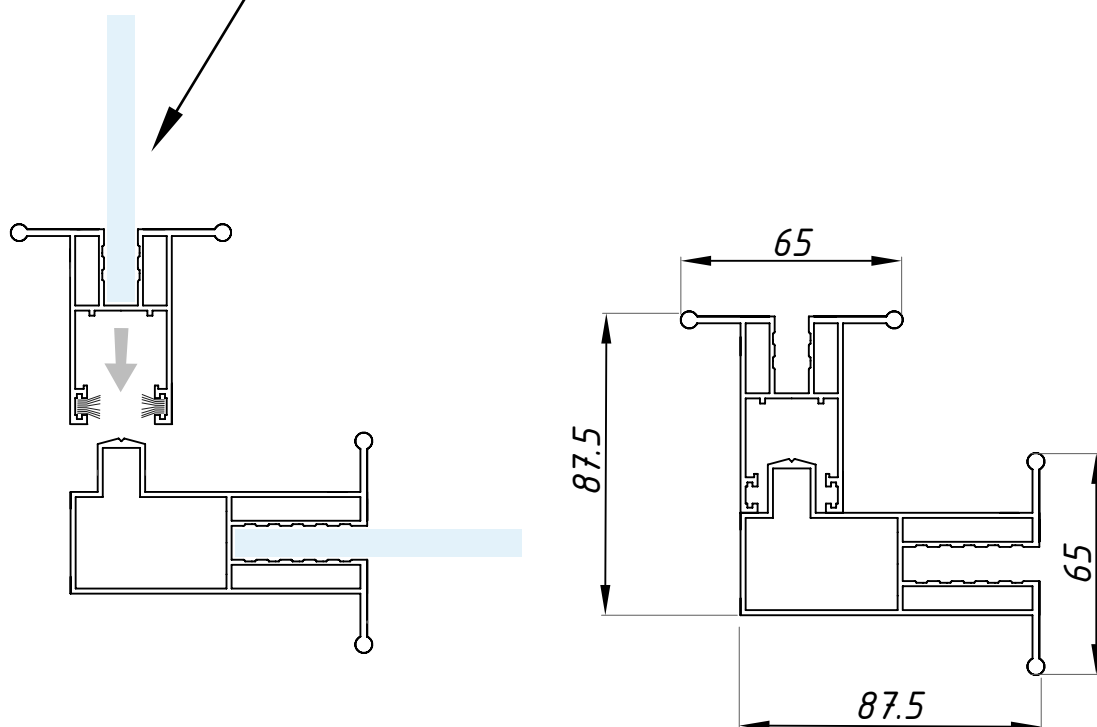
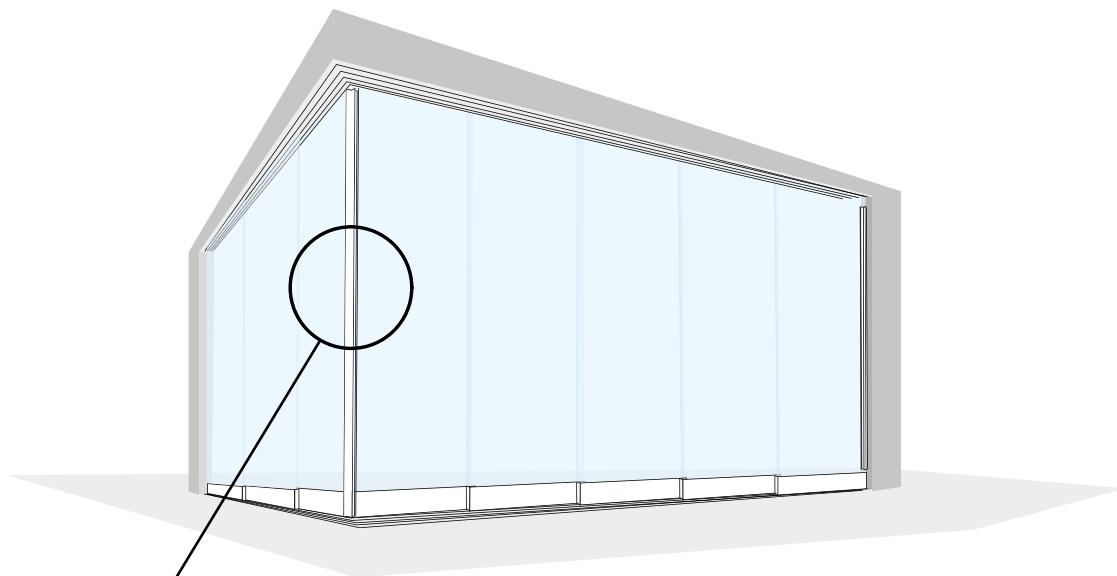

# SPOJ OBOUSTRANNÉHO SYSTÉMU

Set spojovacích profilů oboustranného systému 180°

POVRCHOVÁ  
ÚPRAVA:

RAL 9016

RAL 1013

RAL 9007

RAL 8019

RAL 7016

RAL 8014

RAL 9005

